

NEWS 139 APRILE APRIL 2026



TEMPO LIBERO
LAMPADINE
AUDIO/VIDEO
INTERNO
PRODOTTI CHIMICI
PRODOTTI SU MISURA
PORTAGGIO



INTERNO
ILLUMINAZIONE



ELETTRICO
ILLUMINAZIONE



ILLUMINAZIONE
RICAMBI

LAMPA[®]

4
PCSFluorescent
Fluorescent**PICCHETTI FLUORESCENTI, SET 4 PZ**

- Testa fluorescente per essere visibili anche al buio
- Con occhiello per un facile fissaggio delle corde della tenda e gancio per estrazione facile
- Utilizzabili anche per roccia e terreni molto duri
- In acciaio Q235

40700 203 x 6,5 mm

Scatola / Box 12

FLUORESCENT PEGS, SET OF 4 PCS

- Fluorescent head top to be visible in low light
- With peg puller eyelet
- Can also be used for rock and very hard ground
- Made of Q235 steel

4
PCSTesta / Head
13 mmAdattatore
incluso
Included
adapter**PICCHETTI A VITE CON TESTA DA 13 MM**

- Gambo a vite per utilizzo intensivo su tutti i terreni, anche quelli molto duri o rocciosi
- Testa in plastica con forma ergonomica per fissare saldamente i tiranti della tenda
- Testa in colore altamente visibile
- Può essere usato con adattatore da 13 mm (incluso)
- In acciaio Q235

40701 183 x 7,3 mm

Scatola / Box 12

13 MM SCREW HEAD PEGS, SET OF 4 PCS

- Screw shank for intensive use on all soils, even very hard or rocky soils
- Plastic head with ergonomic shape to firmly fix the curtain ropes
- Hi-viz fixed top
- Can be used with 13 mm adapter (included)
- Made of Q235 steel

4
PCSTesta / Head
13 mmPunta a cavatappi
Corkscrew rod**PICCHETTI CON ASTA A CAVATAPPI, SET 4 PZ**

- Mezzo gambo a vite per essere inserito facilmente nei terreni anche duri e rocciosi
- Testa colorata ad alta visibilità in plastica con forma ergonomica per fissare saldamente i tiranti della tenda
- Asta a cavatappi per una maggiore presa
- In acciaio Q235

40702 203 x 7,3 mm

Scatola / Box 12

PEGGS WITH CORKSCREW ROD, SET OF 4 PCS

- Half screw stem to be easily inserted into soils, even hard and rocky ones
- High visibility colored plastic head with ergonomic shape to securely fasten tent guy lines
- Corkscrew rod for a higher grip
- Made of Q235 steel

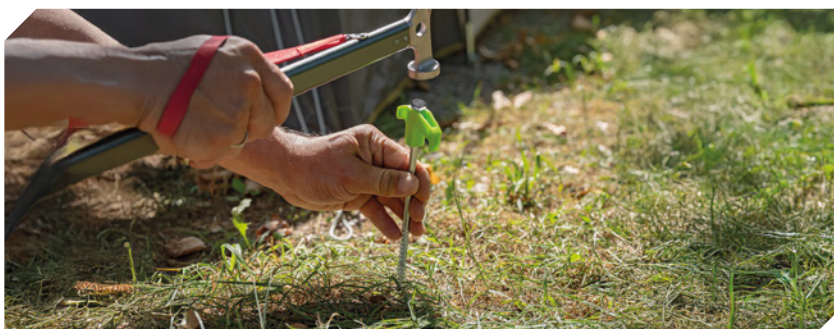

**VENTOSA CON UNCINO PER ANCORAGGIO**

- Per fissare tende da sole, tendalini, teloni etc. senza bisogno di forare
- È sufficiente posizionarla su una superficie pulita e liscia e abbassare la leva per fissarla
- Utilizzabile anche per appendere zaini, borse e altri oggetti

20167 Ø 100 mm / max 10 kg**NEW 20168** Ø 120 mm / max 15 kg

Scatola / Box 6 / 24

SUCTION CUP WITH ANCHORING HOOK

- Screwless mounting of porch, sun sail etc.
- Place the suction cup on a clean, dry, smooth surface of the vehicle and press the lever down
- Can also be used to hang backpacks, bags and other objects

**PIASTRA DI ANCORAGGIO A TERRA PER ANIMALI DOMESTICI**

- Ideale per ancorare il guinzaglio di cani e gatti quando ci si trova all'aperto.
- La piastra può essere bloccata sotto la ruota dell'auto, della roulotte o del camper, oppure fissata al terreno attraverso 4 picchetti Ø 10mm (non inclusi).
- Realizzata in ferro zincato.

60489

Cavaliere / Heather 24

GROUND ANCHOR PLATE FOR PETS

- Ideal for securing the leash of dogs and cats when outdoors.
- The plate can be locked under the wheel of a car, caravan, or motorhome, or fixed to the ground using 4 stakes Ø 10 mm (not included).
- Made of galvanized iron.

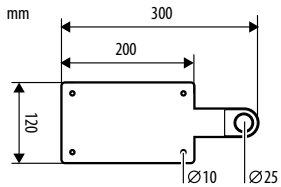
**MANIGLIA DI MANOVRA PER RUOTINO**

- Adatta per tutti i ruotini con diametro esterno del tubo da 48 mm
- Fissaggio facile con solo 4 viti (includere)
- Adatta per roulotte e rimorchi di ogni genere

JOCKEY WHEEL WINDING HANDLE

- Suitable for all 48 mm round tube jockey wheels
- Easy fixing with only 4 screws (included)
- Suitable for caravans and trailers of all kinds

71542

Scatola / Box 48

**Ø 48 mm**



1 PC

HALO LED URANUS SERIES

QUICK-FIT

12/24V LED

6000 K



FANLESS
Heat dissipation
Raffreddamento dinamico
senza ventola

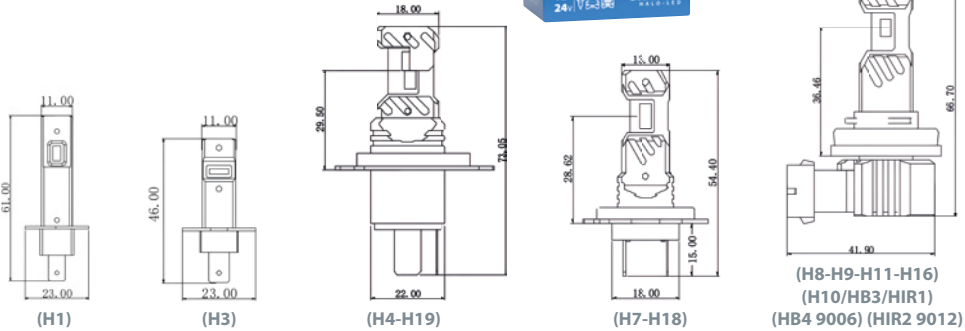

CENTRALINA INTERNA
INTERNAL BALLAST

PLUG & PLAY

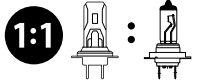

LED = 100% HALOGEN

Lampade LED per abbaglianti e anabbaglianti con sistema plug & play: non sono necessari adattatori e cappucci

LED high and low beams lamps with plug & play system: no adapters and caps needed.

Tipo	Volt	Attacco	Watt	Lumen/pc		Temp. colore	Cod.	Pz	Conf.	Imballo
				Freddo	Caldo					
(H1)	12/24V	P14,5s	11W	1500 lm	1100 lm	6.000° K	57640	1	Scatola	10 / 100
(H3)	12V	PK22s	20W	2020 lm	1100 lm	6.000° K	57641	1	Scatola	10 / 100
(H4-H19)	12/24V	P43t / PU43t-3	20W	1900/1300 lm	1150/780 lm	6.000° K	57642	1	Scatola	10 / 100
(H7-H18)	12/24V	PX26d/PY26d-1	20W	2090 lm	1500 lm	6.000° K	57643	1	Scatola	10 / 100
(H8-H9-H11-H16)	12/24V	PGJ19-X	20W	1800 lm	1100 lm	6.000° K	57644	1	Scatola	10 / 100
(H10/HB3/HIR1)	12/24V	P20d	20W	1800 lm	1100 lm	6.000° K	57645	1	Scatola	10 / 100
(HB4 9006)	12/24V	P22d	20W	1800 lm	1100 lm	6.000° K	57646	1	Scatola	10 / 100
(HIR2 9012)	12/24V	PX22d	20W	1800 lm	1100 lm	6.000° K	57647	1	Scatola	10 / 100

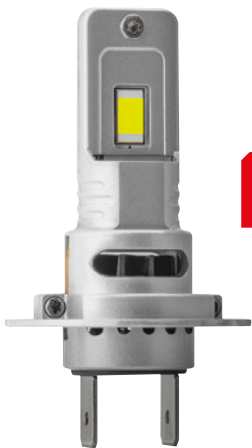

1 PC

HALO LED NEPTUNE SERIES

QUICK-FIT

12/24V LED

6000 K

ELEVATA RESA LUMINOSA
HIGH-LUMEN OUTPUT



RAFFREDDAMENTO CON VENTOLA AD ALTA VELOCITÀ
FAN HEAT DISSIPATION

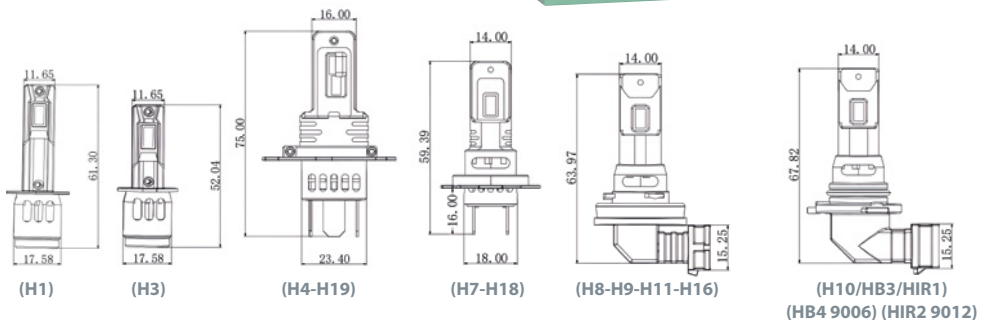

CENTRALINA INTERNA
INTERNAL BALLAST

PLUG & PLAY

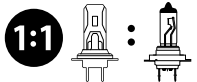

LED = 100% HALOGEN

Lampade LED per abbaglianti e anabbaglianti con sistema plug & play: non sono necessari adattatori e cappucci

LED high and low beams lamps with plug & play system: no adapters and caps needed.

Tipo	Volt	Attacco	Watt	Lumen/pc		Temp. colore	Cod.	Pz	Conf.	Imballo
				Freddo	Caldo					
(H1)	12/24V	P14,5s	35W	3435 lm	1810 lm	6.000° K	57650	1	Scatola	10 / 100
(H3)	12/24V	PK22s	35W	3435 lm	1810 lm	6.000° K	57651	1	Scatola	10 / 100
(H4-H19)	12/24V	P43t / PU43t-3	35W	3430/2100lm	2660/1500 lm	6.000° K	57652	1	Scatola	10 / 100
(H7-H18)	12/24V	PX26d/PY26d-1	35W	3435 lm	2500 lm	6.000° K	57653	1	Scatola	10 / 100
(H8-H9-H11-H16)	12/24V	PGJ19-X	38W	3435 lm	2310 lm	6.000° K	57654	1	Scatola	10 / 100
(H10/HB3/HIR1)	12/24V	P20d	38W	3435 lm	2310 lm	6.000° K	57655	1	Scatola	10 / 100
(HB4 9006)	12/24V	P22d	38W	3435 lm	2310 lm	6.000° K	57656	1	Scatola	10 / 100
(HIR2 9012)	12/24V	PX22d	38W	3435 lm	2310 lm	6.000° K	57657	1	Scatola	10 / 100

OPTI TAG DUO

Questo dispositivo può funzionare sia con la rete "Find my" di Apple che con Find Hub, ma questi due servizi non possono essere attivi contemporaneamente. L'attivazione di uno dei due disattiverà automaticamente l'altro.

This device can work with either the Apple Find My network or Find Hub, but these two services cannot operate simultaneously. Activating one will automatically disable the other.



Detection



Notifications



Sound



SMART TRACKER COMPATIBILE CON APPLE E ANDROID
Localizzatore compatibile con l'app Find Hub di Google e Apple Find My. Configurazione facile tramite l'app, si collega rapidamente al dispositivo. All'interno della confezione anche un pratico porta localizzatore. Per rintracciare un oggetto nelle vicinanze, puoi anche far suonare il suo altoparlante integrato.

SMART TRACKER COMPATIBLE WITH APPLE & ANDROID
Compatible with Google's Find Hub app and Apple Find My. Easy setup, quickly connects to the device. Inside the box you will find the device and a handy tracker holder. To locate an item nearby, you can also make its built-in speaker sound

91765

Scatola / Box 10 / 100

Apple Find My
Google Find Hub

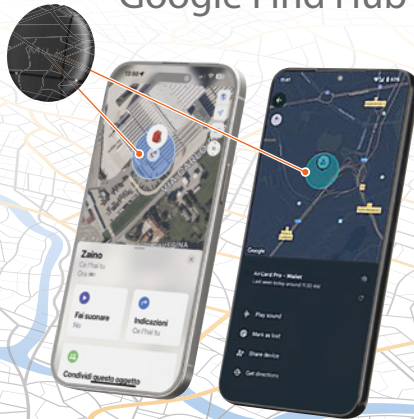

RIPIANO ESPOSITIVO PER DISPLAY
DISPLAY SHELF FOR DISPLAYS

99436 35x20x6 cm

Busta / Bag 10



L 160x85 cm

DELUXE NERO OPACO
MATTE BLACK

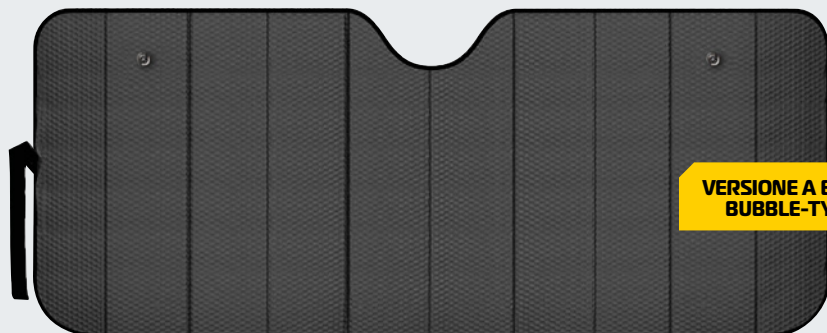

**VERSIONE A BOLLE
BUBBLE-TYPE**

Lato riflettente
Reflective side

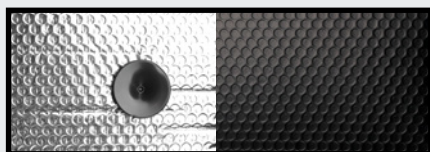

Lato estetico
Aesthetic side

SCUDO TERMICO PER PARABREZZA FURGONI NERO OPACO

Massima protezione dal sole per il cruscotto, volante, sedili ed interni auto. Chiusura con nastro a velcro. Si posiziona in pochi secondi tramite due ventose

VAN MATTE SUNSHADE - MATT BLACK

Ultra-protection from sun rays for the dashboard, steering wheel, seats and car interiors. Closure with velcro strap. Easy mounting with 2 suction cups

66825 **L** 160x85 cm

Cavaliere / Header 12

Fissaggio a ventosa
Suction cup mount



ESSENTIAL CAPS 2 IN 1

CALZE-TENDINE PARASOLE LATERALI POSTERIORI, SET 2 PEZZI

- Doppia funzione: parasole e antinsetti
- Riducono la luce solare e proteggono dai raggi UV, mantenendo una buona visibilità
- Impediscono l'ingresso di insetti, anche con il finestrino aperto
- Tessuto 100% poliestere elastico e traspirante per una vestibilità stabile e sicura

TIGHTS SUNSHADE FOR REAR SIDE WINDOWS, SET OF 2 PIECES

- Dual function: sunshade and insect screen
- They reduce sunlight and protect against UV rays while maintaining good visibility
- They prevent mosquitoes and flies from entering, even with the window open
- Elastic and breathable 100% polyester fabric for a stable and secure fit

**2
PCS**

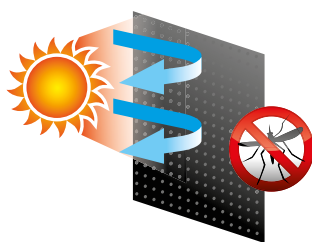

66891	M	60~90 x 50 cm
66892	L	70~105 x 50 cm
66893	XL	80~126 x 52 cm

Scatola / Box 24





KIT SALVIETTINE RIGENERANTI SPECIFICO PER LENTI FARI

- Rimuovono ossidazione, ingiallimento e opacità utilizzando abrasivi di precisione
- Restituiscono la trasparenza in soli due semplici passaggi
- Guida notturna più sicura, migliore visibilità.

TW38591

Scatola / Box 6



SALVIETTINE RIGENERANTI MULTIUSO, 8 PZ

- Rimuovono l'ossidazione dai fari ingialliti, residui di vernice, graffi leggeri, macchie d'acqua, segni a spirale, insetti e altro ancora;
- Progettate per un ripristino delicato ma potente senza compromettere la superficie o intaccare le vernici trasparenti;
- Multiuso, ideali per carrozzeria, cristalli, superfici cromate, acciaio inox, superfici plastiche;
- Confezionate in modo pratico per un utilizzo monouso, senza necessità di ricorrere a prodotti chimici aggressivi né a strumenti complessi

TW38590

Scatola / Box 6



DETERGENTE PER CERCHI

Rimuove rapidamente lo sporco da tutti i cerchi, donando loro una lucentezza che li fa sembrare come nuovi. La sua formula acida ad azione rapida elimina efficacemente la polvere dei freni ostinata, l'olio e lo sporco stradale. Adatto per l'uso su cerchi in lega, in acciaio e copricerchi in plastica e non danneggia le finiture in plastica, le decalcomanie o i fianchi degli pneumatici.

TW38592 750 ml

Nebulizzatore / Trigger spray 6



1 & DONE DETAILER, DETERGENTE INTERNI ED ESTERNI

Soluzione all-in-one definitiva per pulire, lucidare e proteggere l'intera auto, perfetto per rapidi ritocchi tra un lavaggio e l'altro. Il suo potere pulente versatile rimuove facilmente polvere, pelucchi, sporco, polline e altri residui quotidiani dalle superfici sia interne che esterne. Sicuro da usare su vinile, plastica, gomma, pelle, finiture verniciate, ruote, vetro e persino schermi tecnologici, questa formula avanzata offre una pulizia delicata ma efficace ovunque ne abbiate bisogno

TW38589 500 ml

Nebulizzatore / Trigger spray 6





MARCA	MODELLO	ANNO	Nocciola	Beige	Grigio/Nero	Nero/Blu	Nero/Rosso	Nero/Grigio
AUDI	A5 4p S5	09/24>	QF11113A	QF11113B	QF11113C	QF11113D	QF11113E	QF11113F
	A5 4p S-Line	09/24>	QF11115A	QF11115B	QF11115C	QF11115D	QF11115E	QF11115F
	Q3	10/11>12/18	QF11114A	QF11114B	QF11114C	QF11114D	QF11114E	QF11114F
	Q3	10/11>12/18	QF11116A	QF11116B	QF11116C	QF11116D	QF11116E	QF11116F
BMW	Serie 1 (E81) 3p	03/07>06/12	QE12087A	QE12087B	QE12087C	QE12087D	QE12087E	QE12087F
	Serie 3 Touring (G21)	08/19>	QF12088A	QF12088B	QF12088C	QF12088D	QF12088E	QF12088F
BYD	Atto 2 Electric	04/25>	QF58001A	QF58001B	QF58001C	QF58001D	QF58001E	QF58001F
	Dolphin Surf 5p Electric	06/25>	QE58003A	QE58003B	QE58003C	QE58003D	QE58003E	QE58003F
	SEAL U 5p Phev	06/24>	QF58002A	QF58002B	QF58002C	QF58002D	QF58002E	QF58002F
CITROEN	C1 3p	06/14>03/21	QE13139A	QE13139B	QE13139C	QE13139D	QE13139E	QE13139F
	Jumpy (van)	01/07>03/16	QB15122A	QB15122B	QB15122C	QB15122D	QB15122E	QB15122F
CUPRA	Terramar	11/24>	QF50003A	QF50003B	QF50003C	QF50003D	QF50003E	QF50003F
DACIA	Duster	03/24>	QD14047A	QD14047B	QD14047C	QD14047D	QD14047E	QD14047F
FIAT	500	07/07>06/19	QC15124A	QC15124B	QC15124C	QC15124D	QC15124E	QC15124F
	500 Hybrid	07/19>11/24	QC15124A	QC15124B	QC15124C	QC15124D	QC15124E	QC15124F
	Grande Panda Hybrid	04/25>	QD15121A	QD15121B	QD15121C	QD15121D	QD15121E	QD15121F
	Scudo (van)	01/07>04/16	QB15122A	QB15122B	QB15122C	QB15122D	QB15122E	QB15122F
FORD	Tourneo Connect	03/22>	QF16168A	QF16168B	QF16168C	QF16168D	QF16168E	QF16168F
	Tourneo Custom	10/12>07/23	QH16169A	QH16169B	QH16169C	QH16169D	QH16169E	QH16169F
	Tourneo Custom	08/23>	QF16170A	QF16170B	QF16170C	QF16170D	QF16170E	QF16170F
	Tourneo Custom	08/23>	QG16167A	QG16167B	QG16167C	QG16167D	QG16167E	QG16167F
	Tourneo Custom	08/23>	QH16171A	QH16171B	QH16171C	QH16171D	QH16171E	QH16171F
	Transit (van)	04/14>	QF16166A	QF16166B	QF16166C	QF16166D	QF16166E	QF16166F
GEELY	Starry EM-i Hybrid	09/25>	QF57004A	QF57004B	QF57004C	QF57004D	QF57004E	QF57004F
HONDA	Civic 5p Hybrid	08/22>	QF17042A	QF17042B	QF17042C	QF17042D	QF17042E	QF17042F
	HR-V Elegance	09/15>10/21	QF17043A	QF17043B	QF17043C	QF17043D	QF17043E	QF17043F
	HR-V Hybrid	11/21>	QF17039A	QF17039B	QF17039C	QF17039D	QF17039E	QF17039F
	Jazz 5p Hybrid	06/20>	QF17041A	QF17041B	QF17041C	QF17041D	QF17041E	QF17041F
	ZR-V Hybrid	08/23>	QF17040A	QF17040B	QF17040C	QF17040D	QF17040E	QF17040F
HYUNDAI	Instar Electric	12/24>	QE18063A	QE18063B	QE18063C	QE18063D	QE18063E	QE18063F
	Instar Electric	12/24>	QE18064A	QE18064B	QE18064C	QE18064D	QE18064E	QE18064F
ISUZU	D-Max Nitro Sport	12/20>	QF43006A	QF43006B	QF43006C	QF43006D	QF43006E	QF43006F
JEEP	Grand Cherokee	04/99>05/05	QF19014A	QF19014B	QF19014C	QF19014D	QF19014E	QF19014F
KG MOBILITY	Korando	11/19>	QF46007A	QF46007B	QF46007C	QF46007D	QF46007E	QF46007F
	Korando	11/19>	QF46008A	QF46008B	QF46008C	QF46008D	QF46008E	QF46008F
MAZDA	3 5p	02/19>	QE23070A	QE23070B	QE23070C	QE23070D	QE23070E	QE23070F
	CX-5	04/12>05/17	QF23069A	QF23069B	QF23069C	QF23069D	QF23069E	QF23069F
MERCEDES	Classe B	02/19>	QF24138A	QF24138B	QF24138C	QF24138D	QF24138E	QF24138F
	Classe E 4p	07/16>10/23	QF24141A	QF24141B	QF24141C	QF24141D	QF24141E	QF24141F
	GLB	06/23>01/26	QF24140A	QF24140B	QF24140C	QF24140D	QF24140E	QF24140F
	Viano	09/03>02/14	QF24142A	QF24142B	QF24142C	QF24142D	QF24142E	QF24142F
	Viano	09/03>02/14	QG24143A	QG24143B	QG24143C	QG24143D	QG24143E	QG24143F
	Vito Tourer	01/15>	QF24139A	QF24139B	QF24139C	QF24139D	QF24139E	QF24139F
	Vito Tourer	01/24>	QH24137A	QH24137B	QH24137C	QH24137D	QH24137E	QH24137F
MG	HS	11/24>	QF51010A	QF51010B	QF51010C	QF51010D	QF51010E	QF51010F
	ZS Hybrid+, Luxury	11/24>	QF51009A	QF51009B	QF51009C	QF51009D	QF51009E	QF51009F
OPEL	Astra J Sports Tourer	11/10>02/16	QE28157A	QE28157B	QE28157C	QE28157D	QE28157E	QE28157F
	Astra K 5p	11/15>11/21	QE28152A	QE28152B	QE28152C	QE28152D	QE28152E	QE28152F
	Crossland X	06/17>09/20	QF28158A	QF28158B	QF28158C	QF28158D	QF28158E	QF28158F
	Frontera Hybrid	09/24>	QF28151A	QF28151B	QF28151C	QF28151D	QF28151E	QF28151F
	Frontera	09/24>	QF28154A	QF28154B	QF28154C	QF28154D	QF28154E	QF28154F
	Frontera	09/24>	QG28153A	QG28153B	QG28153C	QG28153D	QG28153E	QG28153F
	Grandland 5p Hybrid	11/24>	QF28155A	QF28155B	QF28155C	QF28155D	QF28155E	QF28155F
	Zafira Tourer	11/11>12/19	QF28156A	QF28156B	QF28156C	QF28156D	QF28156E	QF28156F
PEUGEOT	108 3p	06/14>03/21	QE13139A	QE13139B	QE13139C	QE13139D	QE13139E	QE13139F
	207 3p	05/06>11/12	QE29126A	QE29126B	QE29126C	QE29126D	QE29126E	QE29126F
	5008 Hybrid	09/24>	QG29127A	QG29127B	QG29127C	QG29127D	QG29127E	QG29127F



**SET FODERE SUPERIOR
SUPERIOR SEAT COVERS**

MARCA	MODELLO	ANNO	Nocciola	Beige	Grigio/Nero	Nero/Blu	Nero/Rosso	Nero/Grigio
PEUGEOT	508 sw GT Line	01/19>	QF29125A	QF29125B	QF29125C	QF29125D	QF29125E	QF29125F
	Expert (van)	01/07>03/16	QB15122A	QB15122B	QB15122C	QB15122D	QB15122E	QB15122F
RENAULT	Clio VI	11/25>	QD30352A	QD30352B	QD30352C	QD30352D	QD30352E	QD30352F
	Master (van)	07/24>	QI30351A	QI30351B	QI30351C	QI30351D	QI30351E	QI30351F
TESLA	Model 3 4p	09/23>	QF41003A	QF41003B	QF41003C	QF41003D	QF41003E	QF41003F
TOYOTA	Aygo 3p	06/14>12/21	QE13139A	QE13139B	QE13139C	QE13139D	QE13139E	QE13139F
VOLKSWAGEN	Caddy Life 5p	01/21>	QG37446A	QG37446B	QG37446C	QG37446D	QG37446E	QG37446F
	T-Roc Life	09/25>	QF37447A	QF37447B	QF37447C	QF37447D	QF37447E	QF37447F
	T-Roc Trend	09/25>	QF37448A	QF37448B	QF37448C	QF37448D	QF37448E	QF37448F
	Tayron R-Line, Hybrid	11/24>	QF37444A	QF37444B	QF37444C	QF37444D	QF37444E	QF37444F
	Tayron R-Line, Hybrid	11/24>	QF37449A	QF37449B	QF37449C	QF37449D	QF37449E	QF37449F
	Tayron	11/24>	QF37451A	QF37451B	QF37451C	QF37451D	QF37451E	QF37451F
	Tayron R-Line, Hybrid	11/24>	QG37450A	QG37450B	QG37450C	QG37450D	QG37450E	QG37450F
	Tiguan R-Line	12/23>	QF37445A	QF37445B	QF37445C	QF37445D	QF37445E	QF37445F
	Transporter T7 (van)	03/25>	QF16170A	QF16170B	QF16170C	QF16170D	QF16170E	QF16170F
	Transporter T7 (van)	03/25>	QG16167A	QG16167B	QG16167C	QG16167D	QG16167E	QG16167F
	Transporter T7 (van)	03/25>	QH16171A	QH16171B	QH16171C	QH16171D	QH16171E	QH16171F
VOLVO	V60	09/18>	QF38033A	QF38033B	QF38033C	QF38033D	QF38033E	QF38033F



**TAPPETI IN GOMMA
RUBBER MATS**

MARCA	MODELLO	ANNO	PZ	FIX	DIS.	NOTE	CODICE
BYD	Atto 3	09/23>	5	x		elettrica	24736
	Dolphin Surf	06/25>	5	x		elettrica	24738
CITROEN	Berlingo Van	06/18>	2	x		fix ovale	97316
	Jumper	01/24>	3	x		manuale	97315
	Spacefourer	06/16>	3	x		versione passeggeri	97317
CUPRA	Formentor	08/24>	4	x		automatico, benzina	24737
DACIA	Bigster	03/25>	4	x		benzina, manuale	24716
FIAT	Doblò Cargo	08/22>	2	x		fix ovale	97316
	Ducato	01/24>	3	x		manuale	97315
	Scudo	01/22>	3	x		versione passeggeri	97317
MERCEDES	Classe E 4p	11/23>	4	x		automatico	24727
	Classe E sw	11/23>	4	x		automatico	24727
MINI	Mini 3p (F66)	03/24>	4	x		automatico, benzina	24743
OPEL	Combo Cargo	09/18>	2	x		fix ovale	97316
	Zafira Life	03/19>	3	x			97317
PEUGEOT	Boxer	01/24>	3	x		manuale	97315
	Partner	09/18>	2	x		fix ovale	97316
	Traveller	06/16>	3	x		versione passeggeri	97317
RENAULT	4 E-Tech	05/25>	5	x		elettrica	24725
TOYOTA	Proace City	05/20>	2	x		fix ovale	97316
	Proace Max	01/24>	3	x		manuale	97315
	Proace Verso	05/16>	3	x		versione passeggeri	97317
VOLKSWAGEN	Tayron	11/24>	4	x		automatico	24740



**VASCHE BAULE
IN GOMMA SINTETICA
SYNTHETIC RUBBER
TRUNK MATS**

MARCA	MODELLO	ANNO	NOTE	CODICE
FIAT	Talento	05/16>	L1	25663
NISSAN	NV300	07/16>	L1	25663
OPEL	Vivaro	01/14>02/19	L1	25663
RENAULT	Trafic	06/14>	L1	25663



**PREMIUM-GUARD
GRIGLIE DIVISORIE**

MARCA	MODELLO	ANNO	NOTE	COD. KIT	COD. GRIGLIA	SET COMPLETO
BYD	Atto 3 Evo	04/26>	N70060	N70071	NKG071A	NKG081A
PORSCHE	Cayenne (elettrica)	01/26>	N70060	N70072	NKG072A	NKG087A

NUOVI KIT AUTO ED AGGIORNAMENTI DI COMPATIBILITÀ - NEW CAR KITS AND COMPATIBILITY UPDATE



AUDI

AUDI Q3 5p 08/25> <i>PROFILO INTEGRATO</i>	SILENZIO CX RL	SILENZIO CX BLACK RL	SILENZIO IN-RAIL	SILENZIO BLACK IN-RAIL	ALUMIA IN-RAIL	HELIO IN-RAIL	HELIO BLACK IN-RAIL	QUADRA IN-RAIL	SNAP ALU IN-RAIL	SNAP STEEL IN-RAIL
	NK410RS0707	NK410RB0707	N15106	N15101	N15056	N15066	N15061	N15051	NK410SAL	NK410SSL
	N15205	N15225	N15086	N15081	N15026	N15076	N15071	N15021	N15017	N15016
	N15205	N15225	N20022	N20022	N20022	N20022	N20022	N20021	N21410	N21410

BYD

BYD Seal 6 Touring 09/25> <i>PROFILO INTEGRATO</i>	SILENZIO CX RL	SILENZIO CX BLACK RL	SILENZIO IN-RAIL	SILENZIO BLACK IN-RAIL	ALUMIA IN-RAIL	HELIO IN-RAIL	HELIO BLACK IN-RAIL	QUADRA IN-RAIL	SNAP ALU IN-RAIL	SNAP STEEL IN-RAIL
	NK410RS0605	NK410RB0605	N15105	N15100	N15055	N15065	N15060	N15050	NK410SAS	NK410SSS
	N15204	N15224	N15085	N15080	N15025	N15075	N15070	N15020	N15015	N15014
	N15203	N15223	N20022	N20022	N20022	N20022	N20022	N20021	N21410	N21410

FIAT

FIAT 500 Hybrid (no 3+1, no cabrio, no tetto vetro) 11/25> <i>TETTO STANDARD</i>	SILENZIO CX RF	SILENZIO CX BLACK RF	SILENZIO ST	SILENZIO BLACK ST	ALUMIA ST			QUADRA ST		
	NK259TS0807	NK259TB0807	NK259ESM	NK259EBM	NK259EAM			NK259EQM		
	N15406	N15426	N15085	N15080	N15025			N15020		
	N15405	N15425	N20001	N20001	N20001			N20001		
	N20003	N20003	N21259	N21259	N21259			N21259		
	N21259	N21259	SILENZIO LP		ALUMIA LP			QUADRA LP		
			NK259LSM	NK259LBM	NK259LAM			NK259LQM		
			N15085	N15080	N15025			N15020		
			N20002	N20002	N20002			N20002		
			N21259	N21259	N21259			N21259		

MERCEDES

MERCEDES Classe S 12/20> <i>TETTO FIXPOINT</i>	SILENZIO CX RF	SILENZIO CX BLACK RF	SILENZIO ST	SILENZIO BLACK ST	ALUMIA ST	HELIO ST	HELIO BLACK ST	QUADRA ST		
	NK294TS0908	NK294TB0908	NK294ESM	NK294EBM	NK294EAM	NK294EHM	NK294ENM	NK294EQM		
	N15407	N15427	N15085	N15080	N15025	N15075	N15070	N15020		
	N15406	N15426	N20001	N20001	N20001	N20001	N20001	N20001		
	N20003	N20003	N21294	N21294	N21294	N21294	N21294	N21294		
	N21294	N21294	SILENZIO LP		ALUMIA LP	HELIO LP	HELIO BLACK LP	QUADRA LP		
			NK294LSM	NK294LBM	NK294LAM	NK294LHM	NK294LNM	NK294LQM		
			N15085	N15080	N15025	N15075	N15070	N15020		
			N20002	N20002	N20002	N20002	N20002	N20002		
			N21294	N21294	N21294	N21294	N21294	N21294		

RENAULT

RENAULT Clio VI 11/25> <i>TETTO STANDARD</i>	SILENZIO CX RF	SILENZIO CX BLACK RF	SILENZIO ST	SILENZIO BLACK ST	ALUMIA ST	HELIO ST	HELIO BLACK ST	QUADRA ST		
	NK235TS0908	NK235TB0908	NK235ESM	NK235EBM	NK235EAM	NK235EHM	NK235ENM	NK235EQM		
	N15407	N15427	N15085	N15080	N15025	N15075	N15070	N15020		
	N15406	N15426	N20001	N20001	N20001	N20001	N20001	N20001		
	N20003	N20003	N21235	N21235	N21235	N21235	N21235	N21235		
	N21235	N21235	SILENZIO LP		ALUMIA LP	HELIO LP	HELIO BLACK LP	QUADRA LP		
			NK235LSM	NK235LBM	NK235LAM	NK235LHM	NK235LNM	NK235LQM		
			N15085	N15080	N15025	N15075	N15070	N15020		
			N20002	N20002	N20002	N20002	N20002	N20002		
			N21235	N21235	N21235	N21235	N21235	N21235		

NUOVI KIT FURGONI ED AGGIORNAMENTI DI COMPATIBILITÀ - NEW VANS KITS AND COMPATIBILITY UPDATE



FORD

FORD - Tourneo Courier 11/23>	2 barre/bars cm 135		2 barre/bars cm 135	
	N10005 x 2		N10035 x 2	
	N30452 x 1		N30452 x 1	

DELUXE NERO OPACO
MATTE BLACK



**VERSIONE A BOLLE
BUBBLE-TYPE**

**SCUDO TERMICO PER PARABREZZA CAMION
NERO OPACO**

Massima protezione dal sole per il cruscotto, volante, sedili ed interni auto. Chiusura con nastro a velcro. Si posiziona in pochi secondi tramite ventose

TRUCK MATTE SUNSHADE - MATT BLACK
Ultra-protection from sun rays for the dashboard, steering wheel, seats and car interiors.

Closure with velcro strap. Easy mounting with suction cups

66827	XL	180x90 cm
66826	XXL	240x90 cm

Cavaliere / Header 12

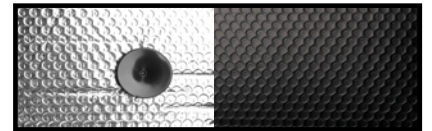

Lato riflettente
Reflective side

Lato estetico
Aesthetic side

XL 180x90 cm

Fissaggio a ventosa
Suction cup mount



XXL 240x90 cm

Fissaggio a ventosa
Suction cup mount



4 LED
12/24V

LUCE INGOMBRO - 4 LED - 12/24V
MARKER LIGHT - 4 LED - 12/24V

96985	Bianco	White	(E) R148-R150-R10
96986	Rosso	Red	(E) R148-R150-R10
96987	Arancio	Amber	(E) R148-R150-R10

Scatola / Box 25 / 100

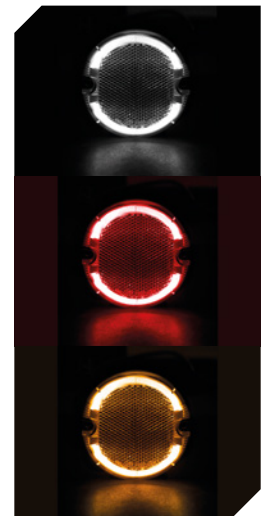
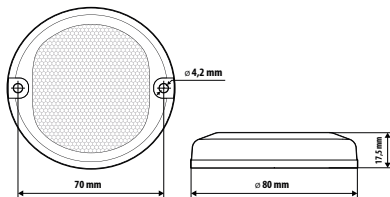

3 PCS

**ORIGINAL KIENZLE, ROTOLI DI CARTA
PER TACHIGRAFI DIGITALI, 3 PZ**

Omologati

**ORIGINAL KIENZLE, ROLLS FOR DIGITAL
TACHOGRAPHS, 3 PCS**

Approved

KIE1381

Scatola / Box 20





BATTERIE MOTO

MOTORCYCLE BATTERIES

AGM

BATTERIA AL PIOMBO-ACIDO, CARICA A SECCO, SENZA MANUTENZIONE

- Griglia delle piastre in lega di piombo-calcio, con bassa perdita d'acqua e basso tasso di autoscarica.
- Maggiore tenuta grazie alla tecnologia di saldatura a caldo.
- Bassa resistenza interna, elevata capacità di scarica ad alta corrente.
- Eccellenti prestazioni a temperature di esercizio elevate e basse (da -30 °C a 55 °C).

DRY CHARGED MAINTENANCE FREE LEAD ACID BATTERY

- Pb-Ca alloy battery plate grid, low water loss and low self-discharge rate.
- Better leak-proofness with heat sealing technology.
- Low internal resistance, high-rate discharge ability.
- Excellent high & low working temperature performance (-30°C to 55°C).



40% Max inclination



Hermetic seal



Maintenance free



Acid pack included

Codice Code	Equivalente a Equivalent to	Capacità (Ah) Capacity (Ah)	Spunto (A) Power (A)	Dimens. (mm) L x P x H	Peso (kg) Weight (kg)	Polarità Polarity	Terminale / Terminal type		
							Fronte	Lato	Alto
XPMTX4LBS	TX4LBS	3	50	113x70x85	1,34	[- +]			
XPMTX5LBS	TX5LBS	4	65	113x70x105	1,48	[- +]			
XPMTZ7BS	TZ7BS	6	80	113x70x105	1,93	[- +]			
XPMTX7LBS	TX7LBS	6	85	113x70x130	2,39	[- +]			
XPMTX7ABS	TX7ABS	6	90	150x87x93	2,40	[+ -]			
XPMT7BBS	T7BBS	6,5	70	150x65x93	1,68	[- +]			
XPMT9BBS	T9BBS	8	90	137x76x134	1,95	[+ -]			
XPMTX9BS	TX9BS	8	110	150x87x105	2,85	[+ -]			
XPMTZ10SBS	TZ10SBS	8,6	150	150x87x93	3,20	[+ -]			
XPMT12ABS	T12ABS	9,5	130	150x87x105	2,31	[- +]			
XPMT12BBS	T12BBS	10	140	150x69x130	2,44	[- +]			
XPMTX12BS	TX12BS	10	160	150x87x130	3,86	[+ -]			
XPMTZ14SBS	TZ14SBS	11,2	190	150x87x110	3,88	[+ -]			
XPMTX14BS	TX14BS	12	180	150x87x145	3,43	[- +]			
XPMTX30LBS	TX30LBS	28	300	167x127x175	5,60	[- +]			

SMF

BATTERIA AL PIOMBO-ACIDO CON VALVOLE DI REGOLAZIONE E ATTIVAZIONE IN FABBRICA

- Ispezione pre-consegna al 100% per garantire una qualità costante e prestazioni affidabili.
- Griglia delle piastre in lega di piombo-calcio, bassa perdita d'acqua e basso tasso di autoscarica.
- Completamente sigillata, esente da manutenzione, basso tasso di autoscarica, ottime proprietà di tenuta.
- Bassa resistenza interna, ottime prestazioni di scarica ad alta intensità.
- Eccellenti prestazioni alle alte e basse temperature di esercizio (da -30 °C a 55 °C).

VALVE REGULATED FACTORY ACTIVATED LEAD ACID BATTERY

- 100% pre-delivery inspection to ensure stable quality and reliable performance.
- Pb-Ca alloy battery plate grid, low water loss and low self-discharge rate.
- Complete sealed, maintenance free, low self-discharge rate, good sealing property.
- Low Internal resistance, good high-rate discharge performance.
- Excellent high & low working temperature performance (-30°C to 55°C).



60% Max
inclination



Hermetic
seal



Maintenance
free



Ready
to use

Codice Code	Equivalente a Equivalent to	Capacità (Ah) Capacity (Ah)	Spunto (A) Power (A)	Dimens. (mm) L x P x H	Peso (kg) Weight (kg)	Polarità Polarity	Terminale / Terminal type		
							Fronte	Lato	Alto
XPMTZ8VBS	TZ8VBS	7	90	113x70x120	2,28				
XPMB9BBS	B9BBS	9	100	137x76x134	2,80				

GEL

BATTERIA AL GEL, SENZA MANUTENZIONE

- Ispezione pre-consegna al 100% per garantire una qualità costante e prestazioni affidabili.
- Griglia delle piastre in lega di piombo-calcio, bassa perdita d'acqua e basso tasso di autoscarica.
- Completamente sigillata, esente da manutenzione, basso tasso di autoscarica, ottime proprietà di tenuta.
- Bassa resistenza interna, ottime prestazioni di scarica ad alta intensità.
- Eccellenti prestazioni alle alte e basse temperature di esercizio (da -30 °C a 55 °C).
- Massima sicurezza ed alta resistenza alle vibrazioni
- Performance brillanti anche in stato di carica parziale

GEL BATTERY, MAINTENANCE FREE

- 100% pre-delivery inspection to ensure stable quality and reliable performance.
- Pb-Ca alloy battery plate grid, low water loss and low self-discharge rate.
- Complete sealed, maintenance free, low self-discharge rate, good sealing property.
- Low Internal resistance, best high-rate discharge performance.
- Excellent high & low working temperature performance (-30°C to 55°C).
- Maximum safety and high resistance to vibrations
- Outstanding performance even in a partial state of charge



60% Max
inclination



Hermetic
seal



Maintenance
free



Ready
to use

Codice Code	Equivalente a Equivalent to	Capacità (Ah) Capacity (Ah)	Spunto (A) Power (A)	Dimens. (mm) L x P x H	Peso (kg) Weight (kg)	Polarità Polarity	Terminale / Terminal type		
							Fronte	Lato	Alto
XPMB19LBS	TB19LBS	19	250	181x77x167	6,08				

FOG-X1 4 LED | 20W | 2123 lm | 6000-6500°K



FOG-X1, KIT FARETTI AUSILIARI FENDINEBBIA A LED

- Robusta struttura in alluminio
- Staffe di fissaggio incluse con inclinazione regolabile
- Kit cablaggio faretto con intermittenza e pulsante incluso

FOG-X1, LED AUXILIARY FOG LIGHT KIT

- Sturdy aluminum structure
- Mounting brackets included with adjustable tilt
- Spotlight wiring kit with flasher and button included

91581 12V - 20W

Scatola / Box 12

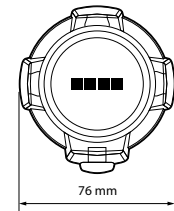
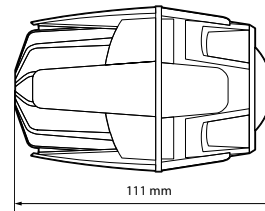

(E) R149



FOG-X2 1 LED | 30W | 2100 lm | 6000-6500°K



FOG-X2, KIT FARETTI AUSILIARI FENDINEBBIA A LED

- Robusta struttura in alluminio
- Staffe di fissaggio incluse con inclinazione regolabile
- Kit cablaggio faretto con intermittenza e pulsante incluso

FOG-X2, LED AUXILIARY FOG LIGHT KIT

- Sturdy aluminum structure
- Mounting brackets included with adjustable tilt
- Spotlight wiring kit with flasher and button included

91582 12V - 30W

Scatola / Box 12

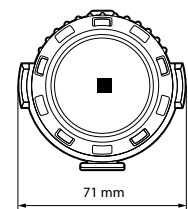
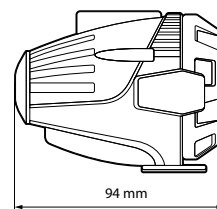

(E) R149





COMPATTA E COMODA
CONVENIENT AND COMPACT

POMPA A PIEDE PORTATILE

- Connettore adatto per valvole Schrader / Presta / Regina
- Struttura in acciaio e plastica
- 2 adattatori gonfia materassi
- 1 ago gonfia palloni
- Peso: 300 g

PORTABLE FOOT PUMP

- Adapter for Schrader / Presta / Regina valve systems
- Steel and plastic structure
- 2 plastic mattress valves
- 1 Sport ball needle
- Weight: 300 g

94237

Scatola / Box 1

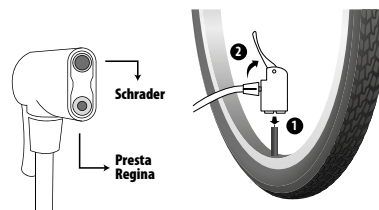

L
250 gr

COPRISELLA CON IMBOTTITURA IN GEL TECNICO - LARGE

- In gel ad alta densità
- Design ergonomico con canale centrale di scarico pressione
- Universale per selle standard (da 27-30 cm)
- Migliora il comfort e la postura
- Chiusura con coulisse regolabile e antiscivolo interno

SEAT COVER WITH TECHNICAL GEL PADDING - LARGE

- Made of high-density gel
- Ergonomic design with central pressure relief channel
- Universal for standard saddles (27-30 cm)
- Improves comfort and posture
- Adjustable drawstring closure and internal anti-slip lining

92360

Cavaliere / Header 50



Ø 28,6 mm



Ø 31,8 mm

COLLARINO REGGISSELLA CON SGANCIO RAPIDO

- In lega di alluminio, leggero, resistente e durevole
- Per tubo sella telaio

QUICK-RELEASE SEATPOST CLAMP

- Made of aluminum alloy, lightweight, strong and durable
- Fits seat tube frames

92345 Ø 28,6 mm

92346 Ø 31,8 mm

Cavaliere / Header 50 / 200



CLASSIC



SELLA CITY CLASSIC

- Design classico, ideale per city bike e bici vintage
- Scala graduata per offrire un'installazione precisa e veloce
- Imbottitura ergonomica per un massimo comfort

CITY CLASSIC SADDLE

- Classic design, ideal for city bikes and vintage bikes
- Graduated scale for quick and precise installation
- Ergonomic padding for maximum comfort

92391 240x210 mm - 660 g

Cavaliere / Header  5 / 10



EVO WIDE



CON MORSETTO
WITH CLAMP

SELLA EVO WIDE CON MORSETTO INTEGRATO

- Superficie ampia per comfort elevato anche su lunghe distanze
- Forma ergonomica che distribuisce il peso e riduce fastidi
- Morsetto integrato per montaggio rapido e compatibile con reggisella standard

EVO WIDE SADDLE WITH INTEGRATED CLAMP

- Wide surface for high comfort, even on long rides
- Ergonomic shape that distributes weight and reduces discomfort
- Integrated clamp for quick installation, compatible with standard seatposts

92392 260x210 mm - 660 g

Cavaliere / Header  5 / 10



EVO



CON MORSETTO
WITH CLAMP

SELLA EVO CON MORSETTO INTEGRATO

- Design snello per maggiore libertà di movimento
- Imbottitura ad alta densità leggera e confortevole
- Forma ergonomica che distribuisce il peso e riduce la pressione
- Morsetto integrato per montaggio rapido e compatibile con reggisella standard

EVO SADDLE WITH INTEGRATED CLAMP

- Slim design for better movement and pedaling efficiency
- High-density padding that absorbs shocks without adding weight
- Ergonomic shape that distributes weight and reduces pressure
- Integrated clamp for quick installation, compatible with standard seatposts

92393 270x160 mm - 530 g

Cavaliere / Header  5 / 10



ECOMOTION WIDE



SELLA ECOMOTION WIDE

- Seduta larga in ETPU per comfort elevato e distribuzione uniforme del peso
- Ottimo assorbimento di urti e vibrazioni su fondi sconnessi
- Materiale leggero, resistente e durevole nel tempo
- Scala graduata per un'installazione precisa e rapida

SADDLE ECOMOTION WIDE

- Wide ETPU seat for enhanced comfort and even weight distribution
- Excellent shock absorption on rough surfaces
- Lightweight, durable, and wear-resistant material
- Graduated scale for precise and quick installation

92394 260x220 mm - 700 g

Cavaliere / Header  5 / 10



ECOMOTION



SELLA ECOMOTION

- Design affusolato per pedalata fluida e libertà di movimento
- Foro centrale che riduce la pressione e migliora il comfort
- Seduta in ETPU leggera e ammortizzante
- Rivestimento ergonomico, stabile e antiscivolo
- Scala graduata per installazione precisa e rapida

SADDLE ECOMOTION

- Slim design for smooth pedaling and freedom of movement
- Central cut-out to relieve pressure and improve comfort
- Lightweight ETPU padding with shock absorption
- Ergonomic, stable, non-slip cover
- Graduated scale for precise and quick installation

92395 270x160 mm - 380 g

Cavaliere / Header  5 / 10



DYNAMIC EVO



SELLA DYNAMIC EVO

- Design sportivo e aerodinamico per pedalata fluida
- Foro centrale che riduce la pressione e aumenta il comfort
- Imbottitura in PU ad alta densità, stabile e ammortizzante
- Rivestimento resistente e antiscivolo per maggiore stabilità
- Scala graduata per installazione precisa e rapida

DYNAMIC EVO SADDLE

- Sporty, aerodynamic design for smooth pedaling
- Central cut-out to reduce pressure and enhance comfort
- High-density PU foam padding for stable support and shock absorption
- Durable, non-slip cover for improved stability
- Graduated scale for precise and quick installation

92396 260x170 mm - 380 g

Cavaliere / Header  5 / 10





1 LED | 550 lm



22,2 - 31,8 mm Ø

5 FUNZIONI
FUNCTIONS**DISCOVERY 550 lm****FANALE ANTERIORE LED, RICARICABILE USB**

- 5 funzioni: luminosità 100-50-25%; lampeggio lento e veloce
- Cinghietto in silicone e staffe di fissaggio con sistema di innesto rapido
- Indicatore batteria scarica
- Batteria ai polimeri di litio 3.7 V / 1800 mAh (ricarica in 5 h circa)
- Cavetto USB Type C incluso

FRONT LED HEADLIGHT, USB RECHARGEABLE

- 5 functions: brightness 100-50-25%; slow and fast flashing
- Silicone strap and quick-release mounting brackets
- Low battery indicator
- Lithium polymer battery 3.7 V / 1800 mAh (recharge in approx. 5h)
- USB Type-C cable included

93546 104x30x39 mm

Scatola / Box ☐ 10 / 50



1 LED | 200 lm



22,2 - 31,8 mm Ø

5 FUNZIONI
FUNCTIONS**DISCOVERY 200 lm****FANALE ANTERIORE LED, RICARICABILE USB**

- 5 funzioni: luminosità 100-50-25%; lampeggio lento e veloce
- Cinghietto in silicone e staffe di fissaggio con sistema di innesto rapido
- Indicatore batteria scarica
- Batteria ai polimeri di litio 3.7 V / 900 mAh (ricarica in 3 h circa)
- Cavetto USB Type C incluso

FRONT LED HEADLIGHT, USB RECHARGEABLE

- 5 functions: brightness 100-50-25%; slow and fast flashing
- Silicone strap and quick-release mounting brackets
- Low battery indicator
- Lithium polymer battery 3.7 V / 900 mAh (recharge in approx. 3h)
- USB Type-C cable included

93545 88x36x24 mm

Scatola / Box ☐ 10 / 50



1 LED | 80 lm



22,2 - 31,8 mm Ø

2 FUNZIONI
FUNCTIONS**SPY****FANALE ANTERIORE A LED**

- Doppia funzione: fanale anteriore o torcia
- Led ad alta luminosità e a basso consumo
- Funzionamento con 3 batterie AAA (non incluse)
- Cinghietto in silicone e staffe di fissaggio con sistema di innesto rapido

FRONT LED LIGHT

- Double function: front light or torch
- High-brightness, low-consumption LED
- Powered by 3 AAA batteries (not included)
- Silicone strap and mounting brackets with quick-release system

93540 99x31x31 mm

Scatola / Box ☐ 10 / 50



1 LED | 20 lm



22,2 - 31,8 mm Ø

2 FUNZIONI
FUNCTIONS

SMART BRIGHT

FANALE ANTERIORE A LED

- 2 funzioni: luce fissa e lampeggiante
- Led ad alta luminosità e a basso consumo
- Cinghietto in silicone e staffe di fissaggio con sistema di innesto rapido
- Funzionamento con 2 batterie AA (non incluse)

FRONT LED LIGHT

- 2 functions: steady light and flashing light
- High-brightness, low-consumption LED
- Silicone strap and mounting brackets with quick-release system
- Powered by 2 AA batteries (not included)

93558 90x30x24 mm

Scatola / Box ☐ 10 / 50



1 LED | 20 lm



22,2 - 31,8 mm Ø

2 FUNZIONI
FUNCTIONS

SUPER BRIGHT

FANALE ANTERIORE A LED

- 2 funzioni: luce fissa e lampeggiante
- Led ad alta luminosità e a basso consumo
- Doppio attacco: cinghietto in silicone per fissaggio rapido al manubrio oppure staffa per attacco a forcella
- Funzionamento con 3 batterie AAA (non incluse)

FRONT LED LIGHT

- 2 functions: steady light and flashing light
- High-brightness, low-consumption LED
- Dual mount: silicone strap for quick handlebar fastening or bracket for fork mounting
- Powered by 3 AAA batteries (not included)

93557 82x34x38 mm

Scatola / Box ☐ 10 / 50



2 LED | 18 lm



22,2 - 31,8 mm Ø

2 FUNZIONI
FUNCTIONS

FRONT LIGHT

FANALE ANTERIORE A LED

- 2 funzioni: luminosità 100% e 50%
- Fissaggio rapido tramite fascetta in silicone
- Funzionamento con 2 batterie CR2032 (incluse)

FRONT LED LIGHT

- Front light with 2 LEDs, white light 18 lm
- 2 modes: 100% and 50% brightness
- Quick fastening with silicone strap
- Powered by 2 CR2032 batteries (included)

92048 45x32x28 mm

Scatola / Box ☐ 10 / 50



10 LED | 30 lm



22,2 - 31,8 mm Ø

8 FUNZIONI
FUNCTIONS

ARROW

FANALE POSTERIORE A LED, RICARICABILE USB

- 8 funzioni - luce fissa: luminosità 100-50-30-15%
- lampeggiante lento: luminosità bassa, media, alta - lampeggiante veloce: luminosità media
- Cinghietto in silicone e staffe di fissaggio con sistema di innesto rapido
- Indicatore batteria scarica
- Batteria ai polimeri di litio 3.7 V / 330 mAh (ricarica in 3 h circa)
- Cavetto USB Type C incluso

REAR LED LIGHT, USB RECHARGEABLE

- 8 functions - steady light: brightness 100-50-30-15%
- slow flashing: low, medium, high brightness - fast flashing: medium brightness
- Silicone strap and quick-release mounting brackets
- Low battery indicator
- Lithium polymer battery 3.7 V / 330 mAh (recharge in approx. 3h)
- USB Type-C cable included

93596 70x20x17 mm

Scatola / Box 10 / 50



20 LED | 20 lm



22,2 - 31,8 mm Ø

6 FUNZIONI
FUNCTIONS

EASY LOGIC

FANALE POSTERIORE A LED, RICARICABILE USB

- 6 funzioni - luce fissa luminosità 100-50-25% - lampeggiante 100-50-25%
- Cinghietto in silicone e staffe di fissaggio con sistema di innesto rapido
- Batteria ai polimeri di litio 3.7 V / 400 mAh (ricarica in 3 h circa)
- Cavetto USB Type C incluso

REAR LED LIGHT, USB RECHARGEABLE

- 6 functions - steady light brightness 100-50-25% - flashing 100-50-25%
- Silicone strap and quick-release mounting brackets
- Lithium polymer battery 3.7 V / 400 mAh (recharge in approx. 3h)
- USB Type-C cable included

93597 49x34x34 mm

Scatola / Box 10 / 50



1 LED | 11m

2 FUNZIONI
FUNCTIONS

CARRIER LIGHT

FANALE POSTERIORE PER PORTAPACCHI

- 2 funzioni: luce fissa e lampeggiante
- Funziona con 2 batterie AAA (non incluse)
- Attacco al portapacchi (distanza viti 50 o 80 mm)
- Catarifrangente integrato omologato IA (E4) 02 3329

REAR CARRIER LED LIGHT

- 2 functions: steady light and flashing light
- Powered by 2 AAA batteries (not included)
- Rack mounting (screw distance 50 or 80 mm)
- Integrated reflector approved IA (E4) 02 3329

93605 93x41x24 mm

Scatola / Box 10 / 50





SQUARE LED



140 LED | 65 lm

140 LED | 20 lm

5 FUNZIONI
FUNCTIONS



KIT FANALI ANTERIORE E POSTERIORE A LED, RICARICABILI USB

- 5 funzioni: luminosità 100% e 50%; lampeggio normale, lento e veloce
- Montaggio universale
- Cinghietto in silicone e staffe di fissaggio con sistema di innesto rapido
- Indicatore batteria scarica
- Batteria ai polimeri di litio 3.7 V / 300 mAh (ricarica in 3 h circa)
- Cavetto USB Type C incluso

FRONT AND REAR LED LIGHT SET, USB RECHARGEABLE

- 5 modes: 100% and 50% brightness; normal, slow and fast flashing
- Universal mounting
- Silicone strap and mounting brackets with quick-release system
- Low battery indicator
- 3.7 V / 300 mAh lithium polymer battery (recharge in about 3 hours)
- USB Type C cable included

93530 41x38x23 mm

Scatola / Box 10 / 50



DIAMOND LED



18 LED | 85 lm

18 LED | 18 lm

6 FUNZIONI
FUNCTIONS



KIT FANALI ANTERIORE E POSTERIORE A LED, RICARICABILI USB

- 6 funzioni: luce fissa luminosità 100-50-25%; luce lampeggiante luminosità 100-50-25%
- Montaggio universale
- Cinghietto in silicone e staffe di fissaggio con sistema di innesto rapido
- Indicatore batteria scarica
- Batteria ai polimeri di litio 3.7 V / 260 mAh (ricarica in 3 h circa)
- Cavetto USB Type C incluso

FRONT AND REAR LED HEADLIGHT KIT, USB RECHARGEABLE

- 6 functions: steady light brightness 100-50-25%; flashing light brightness 100-50-25%
- Universal mounting
- Silicone strap and quick-release mounting brackets
- Low battery indicator
- Lithium polymer battery 3.7V / 260mAh (recharge in approx. 3h)
- USB Type-C cable included

93531 43x41x21 mm

Scatola / Box 10 / 50





DISCOVERY



1 LED | 100 lm

3 FUNZIONI
FUNCTIONS22,2 - 31,8
mm Ø5 FUNZIONI
FUNCTIONS

5 LED | 5 lm

KIT FANALI ANTERIORE E POSTERIORE A LED, RICARICABILI USB

- Anteriore 5 funzioni: luminosità 100-50-25%; lampeggio lento e veloce
- Posteriore 3 funzioni: luce fissa, alternata o lampeggiante
- Cinghietto in silicone e staffe di fissaggio con sistema di innesto rapido
- Indicatore batteria scarica
- Batterie al litio: anteriore 900 mAh, posteriore 330 mAh (ricarica in 3 h circa)
- Cavetto USB Type C incluso

FRONT AND REAR LED HEADLIGHT KIT, USB RECHARGEABLE

- Front 5 functions: brightness 100-50-25%; slow and fast flashing
- Rear 3 functions: steady, alternating or flashing light
- Silicone strap and quick-release mounting brackets
- Low battery indicator
- Lithium batteries: front 900 mAh, rear 330 mAh (recharge in approx. 3h)
- USB Type-C cable included

93535 Ant. 88x36x24 mm - Post. 70x20x25 mm

Scatola / Box 10 / 50



LUMI CLIP



22,2 - 31,8 mm Ø



1 LED | 12 lm

1 LED | 5 lm

2 FUNZIONI
FUNCTIONS**KIT FANALI ANTERIORE E POSTERIORE A LED**

- Ideali anche come luci di segnalazione durante l'attività fisica all'aperto
- 2 funzioni: luce fissa e lampeggiante
- Montaggio universale, adatto per manubri e telai da Ø 22,2 a 31,8 mm
- Fissaggio rapido tramite fascetta in silicone
- Funzionamento con 2x2 batterie CR2032 (incluse)

FRONT AND REAR LED LIGHT SET

- Ideal also as signaling lights during outdoor physical activity
- 2 modes: steady and flashing light
- Universal mounting, suitable for handlebars and frames from Ø 22.2 to 31.8 mm
- Quick fastening with silicone strap
- Powered by 2x2 CR2032 batteries (included)

92047 30x24x30 mm

Scatola / Box 10 / 50





LAMPA S.p.A.

Via G. Rossa, 53/55

46019 Viadana (MN) Italy

Tel. (+39) 0375 820700

✉ info@lampa.it - 🌐 www.lampa.it